

SONY

VIDEO COMMUNICATION SYSTEM-TECHNICAL DOCUMENTATION

Dual Network Interface

IPELA™

PCS-XA80 All
PCS-XG80/XG80S Ver2.0 or later

Introduction

The Sony PCS-XA80/XG80 HD visual communication system has two physical network interfaces. This document describes this dual network feature.

Definition of dual network interface

Advantages of dual network interface

As a result of having two network interfaces, the following advantages are available:

- Connections between local area networks (LAN) and connections between global networks (WAN) via the Internet are possible without having to plug or unplug cables or change the settings.
- By routing terminals on the local network side with terminals on the global network side, it is possible to conduct multi-point conferences with a mixture of local networks and global networks*¹ (Figure 1: Multi-point connection example).
- Although the H.460 firewall traversal function is also available as a solution for seamlessly connecting local network terminals with global network terminals, using this feature makes it easier to connect between a mixture of local networks and global networks because there is no need to install a traversal server or make firewall setting changes.

*1: HD MCU Software PCSA-MCG80 is required separately.

Fig.1: Multi-point connection example (cascade connection)

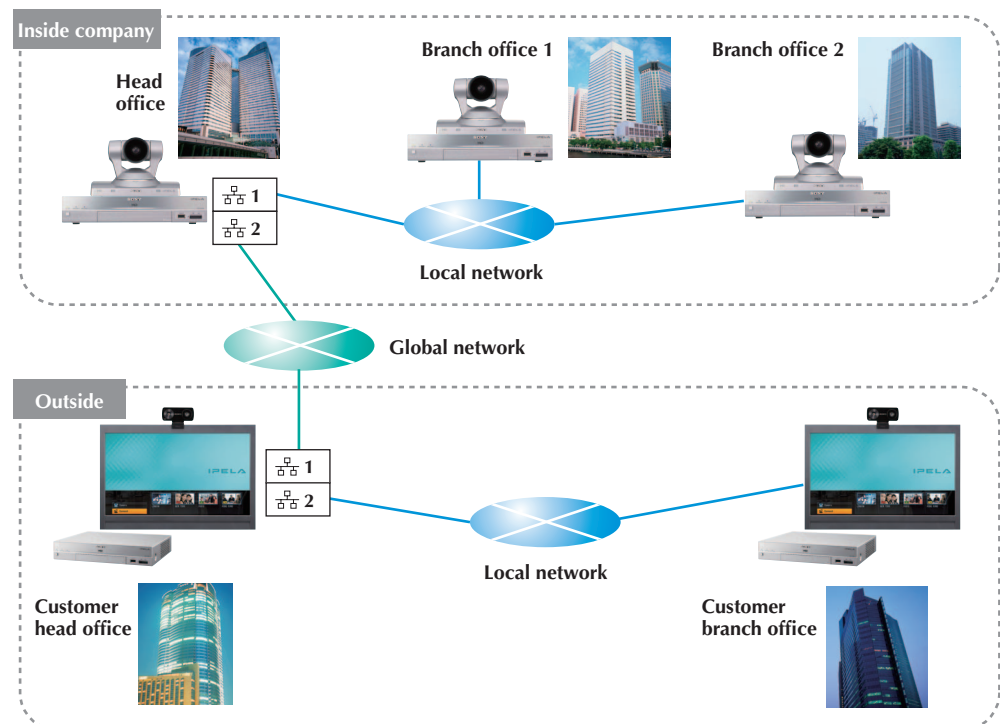

Restrictions

The dual network feature cannot be used under the following conditions:

- When H.460 firewall traversal is enabled
- When using IPv6

Network security

Data transfer between interfaces



Only videoconferencing RTP packets (audio, video, H.239 RGB images, and FECC) are transmitted between  1 (referred to below as LAN port 1) and  2 (referred to below as LAN port 2). No other packets are transmitted (Figure 2).

Fig.2



Furthermore, a network security check has been undergone by a third party and no serious vulnerabilities were observed in this test.

Please ask your local Sony sales branch for details of the test.

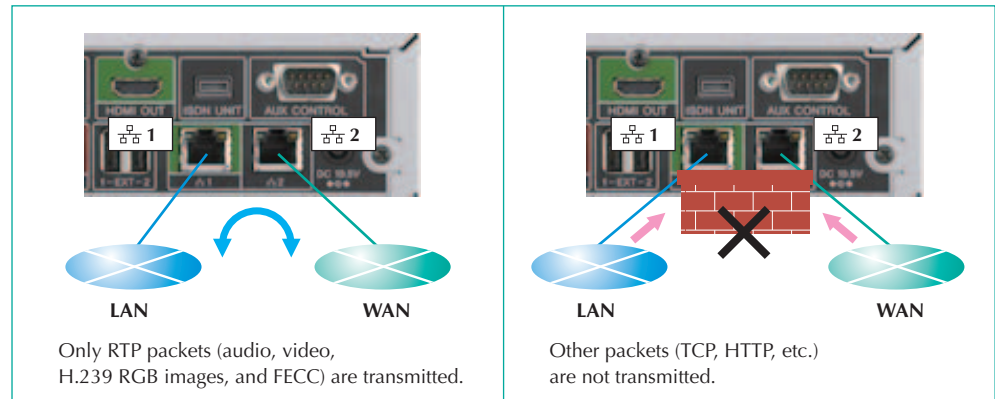
Important information regarding installation/settings

- When using the dual network feature, install and set up LAN port 1 for the local area network and LAN port 2 for the global network (Figure 3). This is because only LAN port 1 has the external access (Telnet, SSH, and Web access) functions for PCS-XA80/XG80. Also, at the same time, set the Remote Access Password in the Administrator Setup menu (Figure 4).

Fig.3

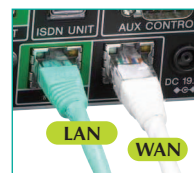
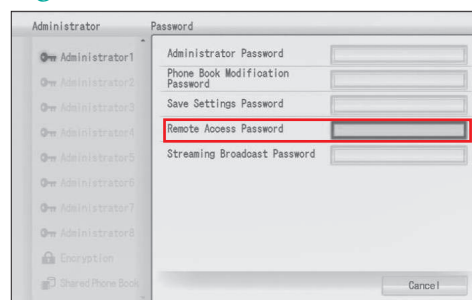
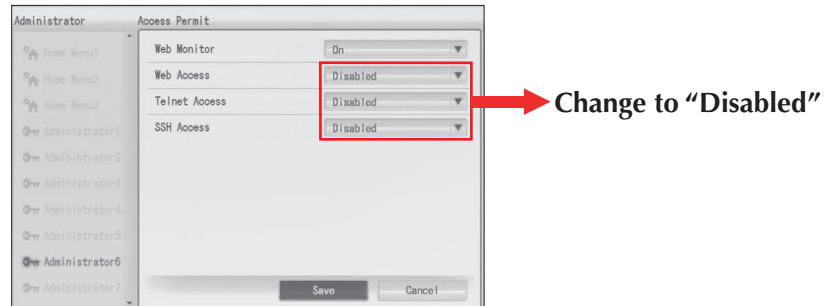

Fig.4



- If, for any reason, the dual network feature is used and LAN port 1 is set up for the global network side, turn off all external access (Telnet, SSH, and Web access) settings in the Administrator Setup menu (Figure 5).

Fig.5



- The settings described below are recommended for the Answer Setup menu in order to prevent unwanted connections from the global network side during a meeting (Figure 6).
Set "Auto Answer" to "Off" (Initial setting: On).
Set "Reject Answer" to "On" (Initial setting: Off)*2.

*2: Available only when the HD MCU software PCSA-MCG80 (available separately) is installed.

Fig.6

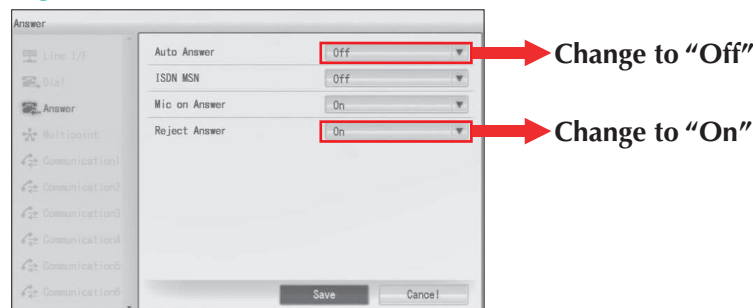

If using the dual network feature as described above, you do not have to bother with plugging and unplugging cables or changing the settings when, for example, you connect with someone outside the office after an in-company meeting. In addition, operation is simple because you can maintain security while following the same procedure as with normal connections, even in meetings that include a mixture of people from inside and outside the company.

- IPELA is a trademark of Sony Corporation.
- In the text mentioned above, PCS-XG80 refers to both the PCS-XG80 and PCS-XG80S.

SONY